



New!

Deep drawn gullies

Industrial Gullies EG

Telescopic System – Vertical Outlet

Product	Height of grate (mm)	Part Nr.	Part Nr.	Product	Part Nr.	Part Nr.
		AISI 304	AISI 316Ti		AISI 304	AISI 316Ti
DN 70 (Ø 75 mm) complet with gully top				Silt basket – low	403201	403202
				higher - for gully without FAT	403203	403204
				Sand basket – low	403230	403231
				higher	403232	403233
without FAT		403098	403101			
with FAT		403092	403095	Foul air trap	403004	403005
DN 70 (Ø 75 mm) with 30 mm flange				Silt basket	05833	15833
				Sieve	05838	15838
without FAT		403243	403246			
with FAT		403237	403240	Foul air trap	E10568	E10581
DN 70 (Ø 75 mm) with bonding flange				O - ring		404037
				Drainage ring		403604
without FAT		403217	403220			
with FAT		403223	403226	Raising piece with bonding flange	05854	15854
DN 70 (Ø 75 mm) with double clamping flange						
				Raising piece with double clamping flange	05851	15851
without FAT		403133	403136			
with FAT		403139	403142	Raising piece with double clamping flange	05851	15851
DN 100 (Ø 110 mm) complet with gully top				Silt basket – low	403201	403202
				higher - for gully without FAT	403203	403204
				Sand basket – low	403230	403231
				higher	403232	403233
without FAT		403100	403103			
with FAT		403094	403097	Foul air trap	403004	403005
DN 100 (Ø 110 mm) with 30 mm flange				Silt basket	05833	15833
				Sieve	05838	15838
without FAT		403244	403247			
with FAT		403238	403241	Foul air trap	E10568	E10581
DN 100 (Ø 110 mm) with bonding flange				O - ring		404037
				Drainage ring		403604
without FAT		403218	403221			
with FAT		403224	403227	Raising piece with bonding flange	05854	15854
DN 100 (Ø 110 mm) with double clamping flange						
				Raising piece with double clamping flange	05851	15851
without FAT		403134	403137			
with FAT		403140	403143	Raising piece with double clamping flange	05851	15851

Body 178

Industrial Gullies EG

Telescopic System – Vertical Outlet

	Product	Height of grate (mm)	Part Nr. AISI 304	Part Nr. AISI 316Ti	Product	Part Nr. AISI 304	Part Nr. AISI 316Ti				
	Body 178	Ø 100 mm with 30 mm flange					Silt basket	05833	15833		
without FAT				403245	403248		Sieve	05838	15838		
with FAT				403239	403242		Foul air trap	E10568	E10581		
Ø 100 mm with bonding flange					O - ring		404037				
without FAT					403219	403222	Drainage ring		403604		
with FAT					403225	403228	Raising piece with bonding flange	05854	15854		
Ø 100 mm with double clamping flange					Raising piece with double clamping flange	05851	15851				
without FAT					403135	403138					
with FAT				403141	403144						

Industrial Gullies EG

Telescopic System – Horizontal Outlet

Product	Height of grate (mm)	Part Nr.	Part Nr.	Product	Part Nr.	Part Nr.
		AISI 304	AISI 316Ti		AISI 304	AISI 316Ti
DN 70 (Ø 75 mm) complet with gully top				Silt basket – low	403201	403202
				higher - for gully without FAT	403203	403204
without FAT		403131	403132	Sand basket – low	403230	403231
with FAT		403129	403130	higher	403232	403233
DN 70 (Ø 75 mm) with 30 mm flange				Foul air trap	403004	403005
				Silt basket	403255	403256
with FAT		403249	403252	Sieve	05838	15838
DN 70 (Ø 75 mm) with bonding flange				O - ring		404037
				Drainage ring		403604
with FAT		403211	403214	Raising piece		
DN 70 (Ø 75 mm) with double clamping flange				with bonding flange	05854	15854
				Raising piece		
with FAT		403205	403208	with double clamping flange	05851	15851
DN 100 (Ø 110 mm) complet with gully top				Silt basket – low	403201	403202
				higher - for gully without FAT	403203	403204
without FAT		403162	403163	Sand basket – low	403230	403231
with FAT		403160	403161	higher	403232	403233
DN 100 (Ø 110 mm) with 30 mm flange				Foul air trap	403004	403005
				Silt basket	403255	403256
with FAT		403250	403253	Sieve	05838	15838
DN 100 (Ø 110 mm) with bonding flange				O - ring		404037
				Drainage ring		403604
with FAT		403212	403215	Raising piece		
DN 100 (Ø 110 mm) with double clamping flange				with bonding flange	05854	15854
				Raising piece		
with FAT		403206	403209	with double clamping flange	05851	15851

Body 178

Industrial Gullies EG

Telescopic System – Horizontal Outlet

Body 178	Product	Height of grate (mm)	Part Nr. AISI 304	Part Nr. AISI 316Ti	Product	Part Nr. AISI 304	Part Nr. AISI 316Ti	
	Ø 100 mm with 30 mm flange					Silt basket	403255	403256
						Sieve	05838	15838
						O - ring		404037
Ø 100 mm with bonding flange					Drainage ring		403604	
with FAT		403251	403254					
Ø 100 mm with double clamping flange					Raising piece with bonding flange	05854	15854	
with FAT		403213	403216					
Ø 100 mm with double clamping flange					Raising piece with double clamping flange	05851	15851	
with FAT		403207	403210					

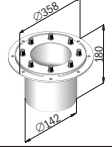
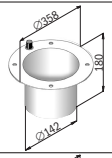
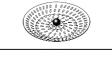
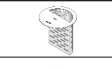
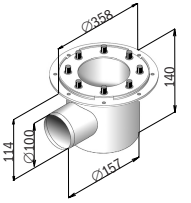
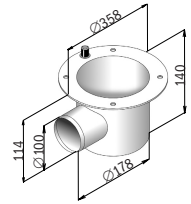
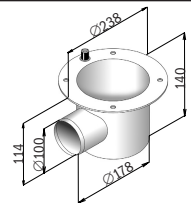

Industrial Gullies EG

Accessories for Telescopic System

Body 157, 178 – Gully Tops

Product	Height of grate (mm)	Part Nr. AISI 304	Part Nr. AISI 316Ti
Industrial gully top	25	05900	15900
	40	05902	15902

Body 157, 178 – size of grate 168 x 168 mm

Product	Surface Loading classes	Height	Part Nr. AISI 304	Part Nr. AISI 316Ti
Mesh grating	antislip	L 25	05910	15910
	antislip	M 40	05912	15912
	plain	L 25	05913	15913
	plain	M 40	05915	15915
Perforated grating - slot		L 25	05928	15928
		L 40	42111	42501
Ladder grating	plain	M 25	05936	15936
	plain	M 40	42113	97161
	antislip	M 25	97353	97354
	antislip	M 40	402093	401695
Slot cover		M 25	05940	15940
		M 40	42114	42504
Solid cover		L 25	05932	15932
		L 40	42112	-
Perforated grating - round holes \varnothing 8		L 25	06960	-
		L 25	05897	-

Body 157, 178 – Round Gully Tops

Product	Height of grate (mm)	Part Nr. AISI 304	Part Nr. AISI 316Ti
Round industrial gully top	30	97100	-
	40	97101	-
Round industrial gully top for vinyl floor	30	92552	92558
	40	92553	92559

Body 157, 178 – size of grate \varnothing 170 mm

Product	Height	Load. classes	Part Nr. AISI 304	Part Nr. AISI 316Ti
Ladder grating	30	M	97146	97367
	40	M	97147	97368
Perforated grating	30	L	97152	97369
Slot cover	30	M	97154	97370
	40	M	97155	97371

Industrial Gullies EG Fixed Height System – Square Gully Top – Vertical Outlet

	Product				Product			
	Height of grate (mm)	Part Nr. AISI 304	Part Nr. AISI 316Ti		Part Nr. AISI 304	Part Nr. AISI 316Ti		
Body 178	DN 70 (Ø 75 mm)				Height of grate 30 mm			
	without FAT	30	403983	403985	Height of grate 40 mm			
	without FAT	40	403984	403986	Silt basket			
	with FAT	30	403979	403981	Sieve			
	with FAT	40	403980	403982	Foul air trap Ø 75 E 10568 E 10581			
	DN 100 (Ø 110 mm)				Height of grate 30 mm			
	without FAT	30	403990	403992	Height of grate 40 mm			
	without FAT	40	403991	403993	Foul air trap Ø 110 E 10589 E 10591			
	with FAT	30	403828	403988				
	with FAT	40	403987	403989				
	Ø 100 mm				Height of grate 30 mm			
	without FAT	30	403998	404000	Height of grate 40 mm			
without FAT	40	403999	404001					
with FAT	30	403994	403996					
with FAT	40	403995	403997					

Fixed Height System – Square Gully Top – Horizontal Outlet

	Product				Product			
	Height of grate (mm)	Part Nr. AISI 304	Part Nr. AISI 316Ti		Part Nr. AISI 304	Part Nr. AISI 316Ti		
Body 178	DN 70 (Ø 75 mm)				Height of grate 30 mm			
	with FAT	30	403821	403824	Height of grate 40 mm			
	with FAT	40	403823	403825	Silt basket			
	DN 100 (Ø 110 mm)				Height of grate 30 mm			
	with FAT	30	403822	404030	Height of grate 40 mm			
	with FAT	40	404029	404031	Sieve			
	DN 150 (Ø 160 mm)				Height of grate 30 mm			
	with FAT	30	404025	404027	Height of grate 40 mm			
	with FAT	40	404026	404028				

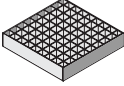
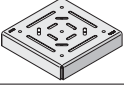
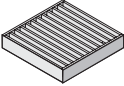
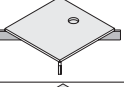
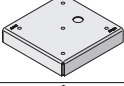
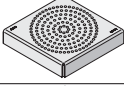
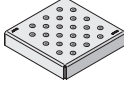

Industrial Gullies EG Accessories for Fixed Height System

Body 178 – size of grate 218 x 218 mm

Product	Surface Loading classes	Height	Part Nr.			
			AISI 304	AISI 316Ti		
Mesh grating	antislip	L	30	05918	15918	
	antislip	M	40	05919	15919	
	plain	L	30	05920	15920	
	plain	M	40	05921	15921	
Perforated grating - slot		L	30	05929	15929	
		L	40	42115	42505	
Ladder grating	plain	M	30	05937	15937	
	plain	M	40	42117	97162	
Slot cover		M	30	05941	15941	
		M	40	42118	-	
Solid cover		L	30	05933	15933	
		L	40	42116	-	
Perforated grating - round holes \varnothing 8		L	30	06961	401561	
Round holes spec.		L	40	05895	15895	

Industrial Gullies EG

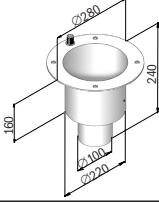
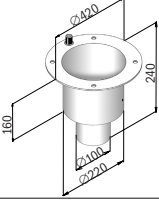
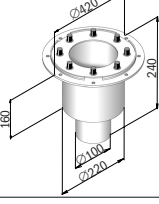
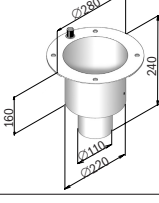
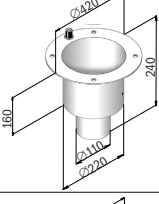
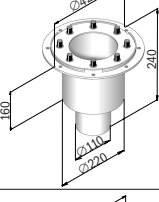
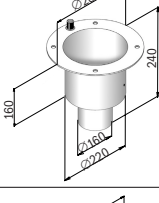
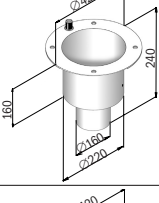
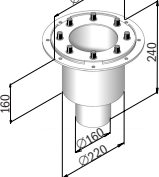
Telescopic System – Vertical Outlet

Product	Height of grate (mm)	Part Nr.		Product	Part Nr. AISI 304	Part Nr. AISI 316Ti
		AISI 304	AISI 316Ti			
Ø 100 mm with 30 mm flange without FAT with FAT						
Ø 100 mm with bonding flange without FAT with FAT						
Ø 100 mm with double clamping flange without FAT with FAT						
DN 100 (Ø 110 mm) with 30 mm flange without FAT with FAT					E 6570	E 6576
DN 100 (Ø 110 mm) with bonding flange without FAT with FAT					E 6566	E 6573
DN 100 (Ø 110 mm) with double clamping flange without FAT with FAT					E 11759	
DN 100 (Ø 110 mm) with bonding flange without FAT with FAT					05855	15855
DN 100 (Ø 110 mm) with double clamping flange without FAT with FAT					05852	15852
DN 150 (Ø 160 mm) with 30 mm flange without FAT with FAT						
DN 150 (Ø 160 mm) with bonding flange without FAT with FAT						
DN 150 (Ø 160 mm) with double clamping flange without FAT with FAT						

Body 220

Industrial Gullies EG

Accessories for Telescopic System

Body 201, 220 – Gully Tops

Product	Height of grate (mm)	Part Nr. AISI 304	Part Nr. AISI 316Ti
Industrial gully top	30	05903	15903
	40	05904	15904

Body 201, 220 – size of grate 218 x 218 mm

Product	Surface Loading classes	Height	Part Nr. AISI 304	Part Nr. AISI 316Ti
Mesh grating	antislip L	30	05918	15918
	antislip M	40	05919	15919
	plain L	30	05920	15920
	plain M	40	05921	15921
Perforated grating - slot	L	30	05929	15929
	L	40	42115	42505
Ladder grating	plain M	30	05937	15937
	plain M	40	42117	97162
Slot cover	M	30	05941	15941
	M	40	42118	-
Solid cover	L	30	05933	15933
	L	40	42116	-
Perforated grating - round holes Ø 8	L	30	06961	401561
Round holes spec.	L	40	05895	15895

Body 201, 220 – Round Gully Tops

Product	Height of grate (mm)	Part Nr. AISI 304	Part Nr. AISI 316Ti
Round industrial gully top	30	97102	-
	40	97103	-
Round industrial gully top for vinyl floor	30	92554	92560
	40	92555	92561

Body 201, 220 – size of grate Ø222 mm

Product	Height	Load. classes	Part Nr. AISI 304	Part Nr. AISI 316Ti
Ladder grating	30	M	97148	97388
	40	M	97149	97389
Perforated grating	30	L	97153	97390
Slot cover	30	M	97156	97391
	40	M	97157	97392



Body 201, 220 – Gully top save edge

Product	Height of grate (mm)	Part Nr. AISI 304	Part Nr. AISI 316Ti
Industrial gully top	30	05801	15801
safe edge	40	05858	15858



Body 201, 220 – size of grate 192 x 192 mm with save edge

Product	Surface Loading classes	Height	Part Nr. AISI 304	Part Nr. AISI 316Ti
Mesh grating	antislip L	30	05805	15805
	antislip M	40	05916	15916
	plain L	30	05813	15813
	antislip M	40	05917	15917
Perforated grating - round holes Ø 8	L	30	05821	15821
	L	30	05894	15894
Ladder grating - plain	M	30	05817	15817
	M	30	05809	15809
Slot cover	M	30	05809	15809
Solid cover	L	30	05825	15825

Industrial Gullies EG Fixed Height System – Square Gully Top – Vertical Outlet



	Product				Product			
	Height of grate (mm)	Part Nr. AISI 304	Part Nr. AISI 316Ti		Part Nr. AISI 304	Part Nr. AISI 316Ti		
Body 220	Ø 100 mm							
	without FAT	30	403854	403857	Silt basket 			
	without FAT	40	403973	403976	Sieve 			
	with FAT	30	403850	403851	Foul air trap Ø 100 E 6570 E 6576			
	with FAT	40	403967	403970	Foul air trap Ø 110 E 6566 E 6573			
					Foul air trap Ø 160 E 11759 			
	DN 100 (Ø 110 mm)							
	without FAT	30	403855	403858				
	without FAT	40	403974	403977				
	with FAT	30	403840	403852				
	with FAT	40	403968	403971				
	DN 150 (Ø 160 mm)							
without FAT	30	403856	403966					
without FAT	40	403975	403978					
with FAT	30	403839	403853					
with FAT	40	403969	403972					

Fixed Height System – Square Gully Top – Horizontal Outlet

	Product				Product			
	Height of grate (mm)	Part Nr. AISI 304	Part Nr. AISI 316Ti		Part Nr. AISI 304	Part Nr. AISI 316Ti		
Body 220	Ø 100 mm							
	with FAT	30			Silt basket 			
	with FAT	40			Sieve 			
	DN 100 (Ø 110 mm)							
	with FAT	30	403834	403843				
	with FAT	40	403842	403844				
	DN 150 (Ø 160 mm)							
	with FAT	30	403833	403832				
	with FAT	40	403831	403835				

Industrial Gullies EG Accessories for Fixed Height System

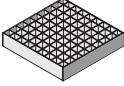
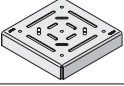
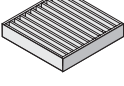
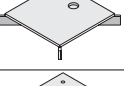
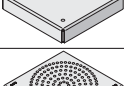
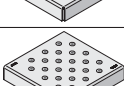
Body 220 – size of grate 268 x 268 mm

Product	Surface Loading classes	Height	Part Nr.			
			AISI 304	AISI 316Ti		
Mesh grating	antislip	L	30	05922	15922	
	antislip	M	40	05923	15923	
	plain	L	30	05924	15924	
	plain	M	40	05925	15925	
Perforated grating - slot		L	30	05930	15930	
		L	40	42119	-	
Ladder grating	plain	M	30	05938	15938	
	plain	M	40	42121	97163	
	antislip	M	30	97393	97394	
	antislip	M	40	402094	401697	
Slot cover		M	30	05942	15942	
		M	40	42122	-	
Solid cover		L	30	05934	15934	
		L	40	42120	-	
Perforated grating - round holes Ø 8		L	30	06962	-	
Round holes spec.		L	30	05898	-	

ACO Industries k.s.

582 22 Přebyslav
Havlíčková 260
Tel.: +420 569 491 111
Fax: +420 569 482 529
www.aco.cz
e-mail: aco@aco.cz
Czech republic