

TAPA DN/OD 110 HP H160 ML SEAL IN V100 0

Tapa con junta estanca labiolaberíntica para salida DN/OD 110 de hormigón polímero, para canales ACO MULTILINE SEAL IN V100. Longitud de 30 mm, altura exterior de 160 mm y ancho exterior de 154 mm. Peso: 1,4 kg.

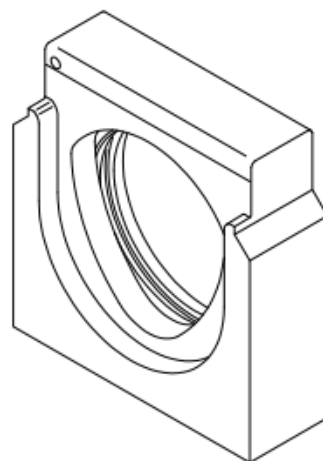
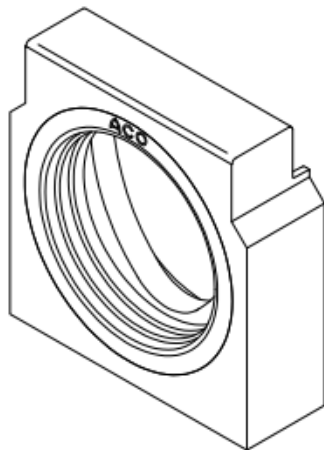
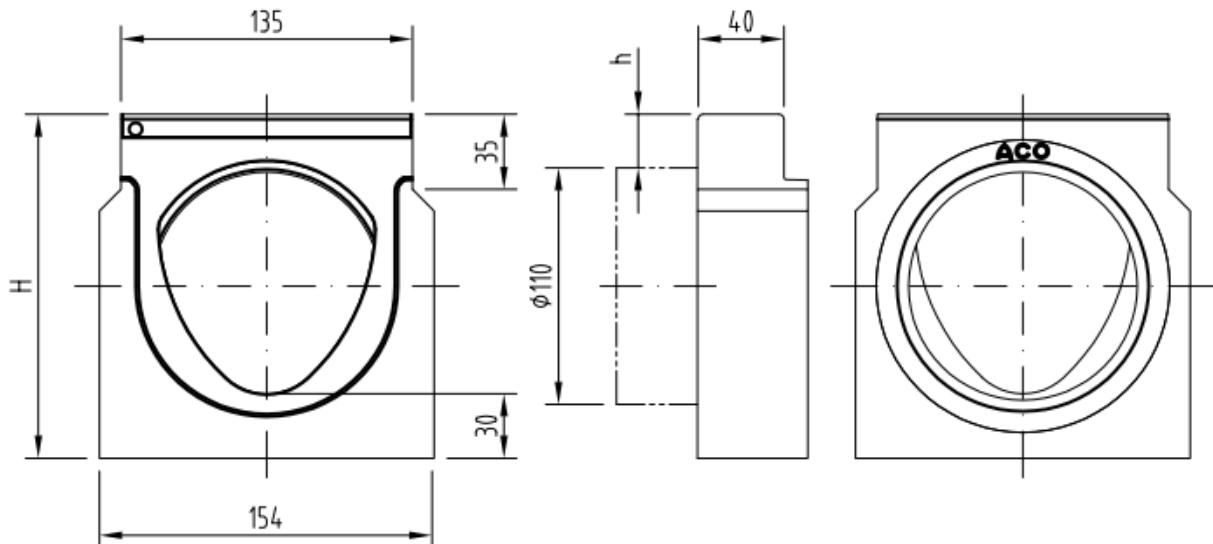

Dimensiones:

Material hormigón polímero

Peso (kg)	1,4
Longitud (mm)	30
Ancho (mm)	154
Altura (mm)	160
Salida	DN/OD 110