

TAMPÃO DN/OD 110 HP H185 ML SEAL IN V100 5

Tampão com junta estanque labial para saída DN/OD 110 em betão polímero, para canais ACO MULTILINE SEAL IN V100. Comprimento de 30 mm, altura exterior 185 mm e largura exterior 154 mm. Peso: 1,5 kg.

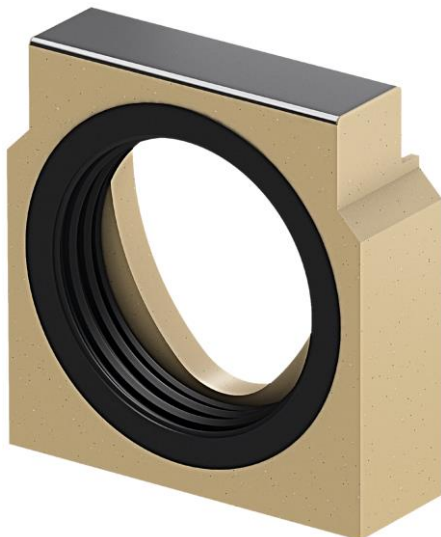
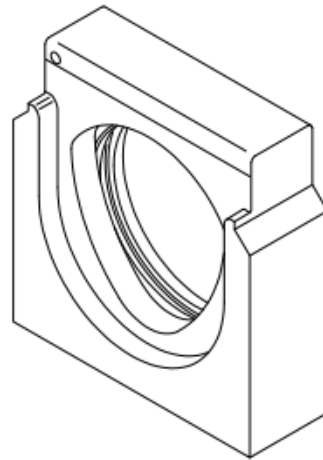
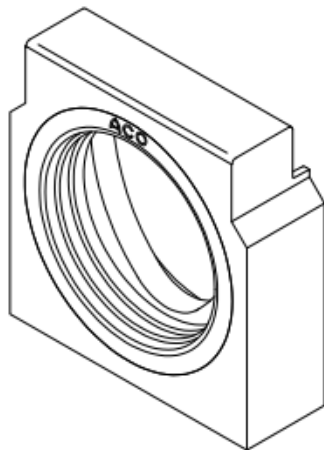
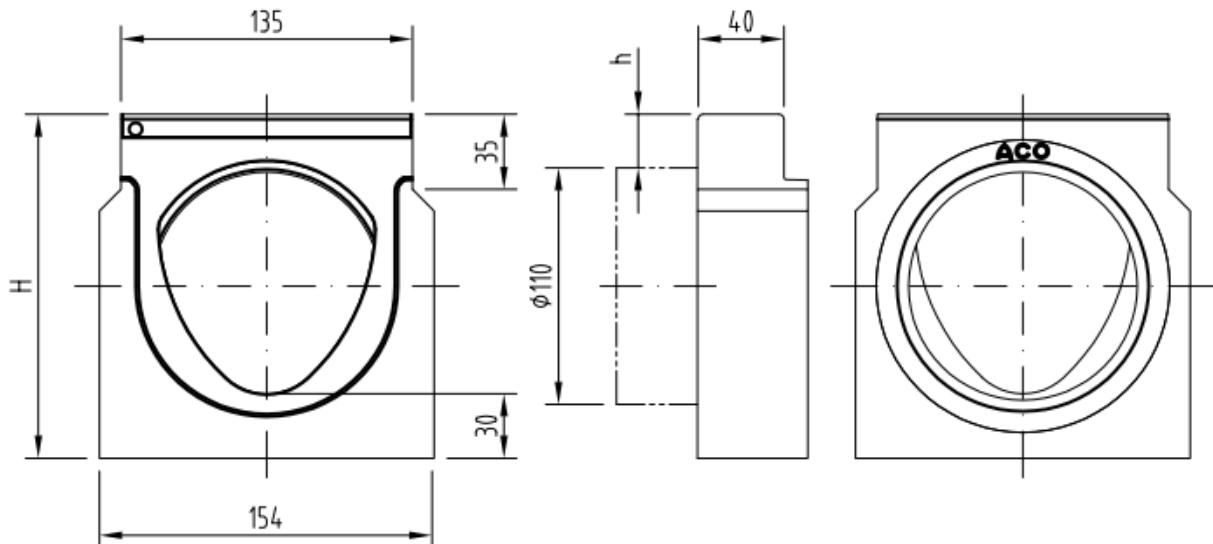

Dimensões:

Material	betão polímero
Peso (kg)	1,5
Comprimento (mm)	30
Largura (mm)	154
Altura (mm)	185
Saída	DN/OD 110