

TAMPÃO DN/OD 110 HP H260 ML SEAL IN V100 20

Tampão com junta estanque labial para saída DN/OD 110 em betão polímero, para canais ACO MULTILINE SEAL IN V100. Comprimento de 30 mm, altura exterior 260 mm e largura exterior 154 mm. Peso: 2,3 kg.

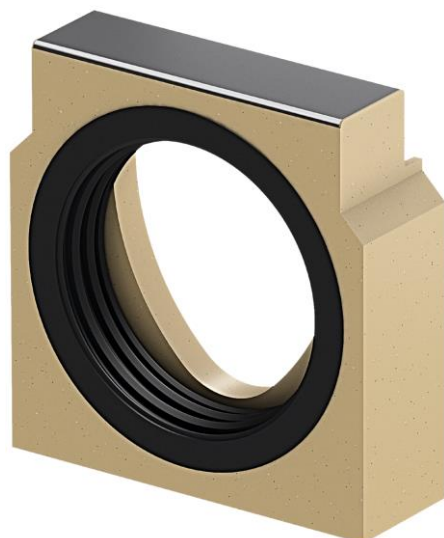
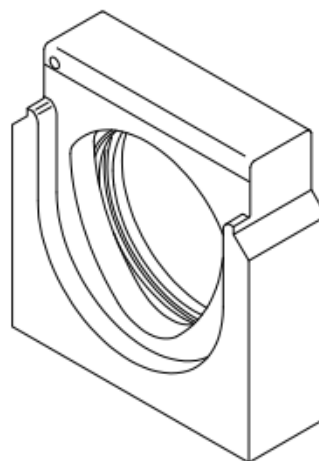
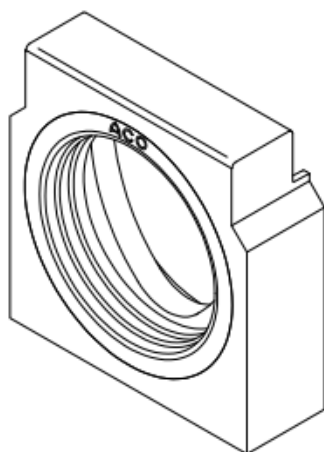
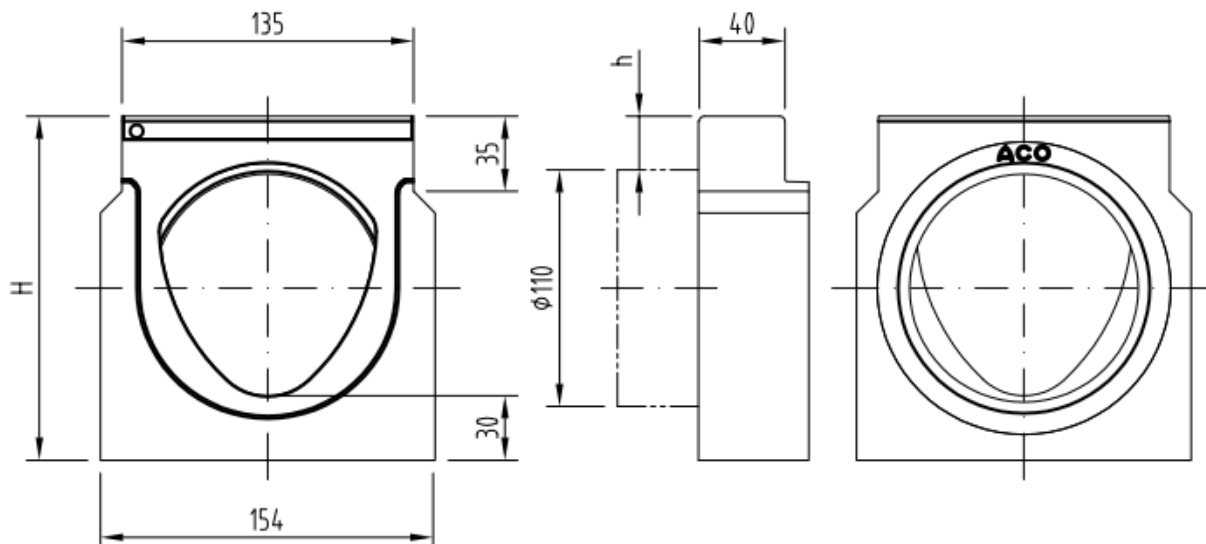

Dimensões:

Material	betão polímero
Peso (kg)	2,3
Comprimento (mm)	30
Largura (mm)	154
Altura (mm)	260
Saída	DN/OD 110