

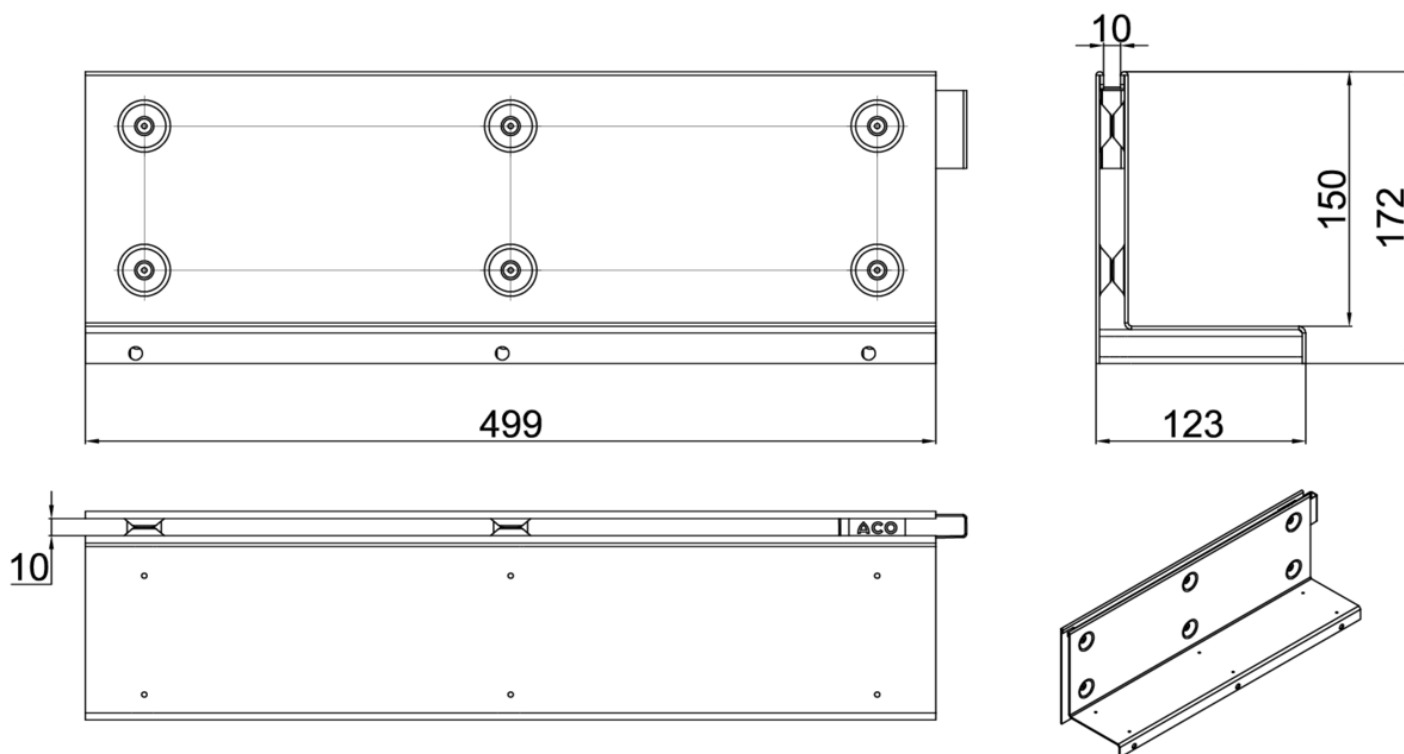

GR MULTIDRAIN/ MULTILINE/XTRADRAIN 100 L500 D400 AISI304 BRICKSLOT-ST L H150 Artigo: 00446025

Grelha BRICKSLOT-ST L em aço inoxidável AISI 304, de classe de carga D400 de acordo com a norma EN1433, para canais de drenagem ACO MULTIDRAIN/ MULTILINE/XTRADRAIN 100. Sem sistema de fixação. Área de absorção de 100 cm²/m. Comprimento total de 500 mm, altura exterior 177 mm e largura exterior 123 mm. Peso: 4,41 kg.



Dimensões:

Modelo	MULTIDRAIN/ MULTILINE/XTRADRAIN 100
Comprimento (mm)	500
Largura (mm)	123
Altura ext. (mm)	177
Peso (kg)	4,41
Área de absorção de grelha (cm ² /m)	100
Classe de carga	D400

