

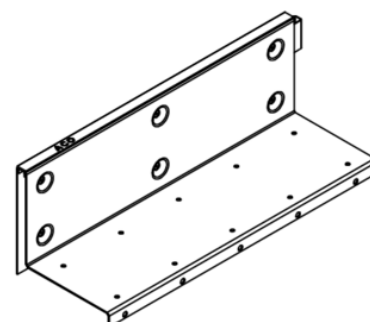

Grelha BRICKSLOT-ST L em aço galvanizado, de classe de carga D400 de acordo com a norma EN1433, para canais de drenagem ACO MULTIDRAIN/ MULTILINE/XTRADRAIN 150. Sem sistema de fixação. Área de absorção de 100 cm²/m. Comprimento total de 500 mm, altura exterior 177 mm e largura exterior 173 mm. Peso: 5,22 kg.

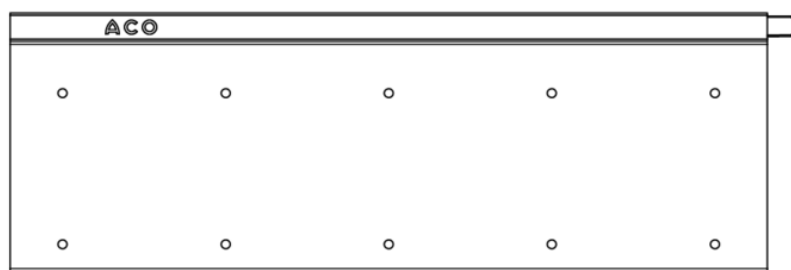
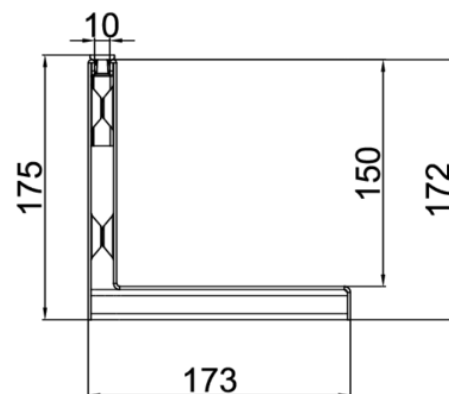
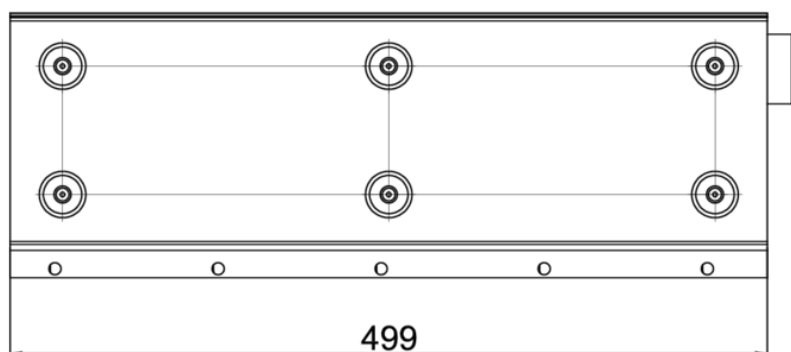

Dimensões:

Modelo	MULTIDRAIN/ MULTILINE/XTRADRAIN 150
Comprimento (mm)	500
Largura (mm)	173
Altura ext. (mm)	177
Peso (kg)	5,22
Área de absorção de grelha (cm ² /m)	100
Classe de carga	D400

