



CANALES DE DRENAJE

ACO DRAIN REJA - MULTIDRAIN/ MULTILINE/XTRADRAIN 150



REJA MULTIDRAIN/ MULTILINE/XTRADRAIN 150 L500 D400 AISI304 BRICKSLOT-ST L H150

Codigo: 00446037

Reja BRICKSLOT-ST L de acero inoxidable AISI 304, de clase de carga D400 según EN1433, para canales de drenaje ACO MULTIDRAIN/ MULTILINE/XTRADRAIN 150. Sin sistema de fijación. Área de absorción de 100 cm²/m. Longitud total de 500 mm, altura exterior 177 mm y ancho exterior 173 mm. Peso: 5,22 kg.

Artículo: 00446037

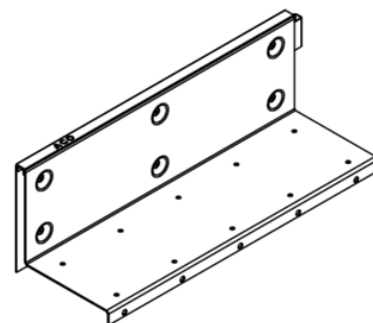
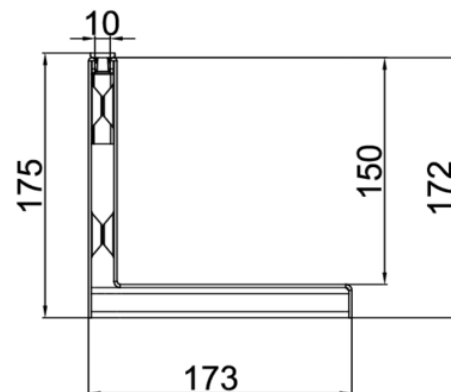
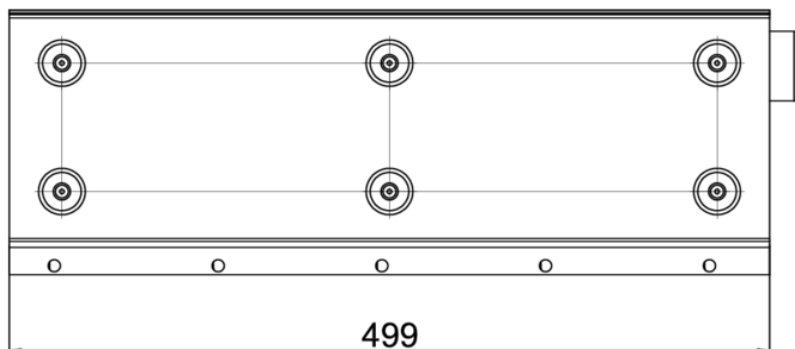

Dimensiones:

Modelo	MULTIDRAIN/ MULTILINE/XTRADRAIN 150
Longitud (mm)	500
Ancho ext. (mm)	173
Altura ext. (mm)	177
Peso (kg)	5,22
Área absorción reja (cm ² /m)	100
Clase de carga	D400

