

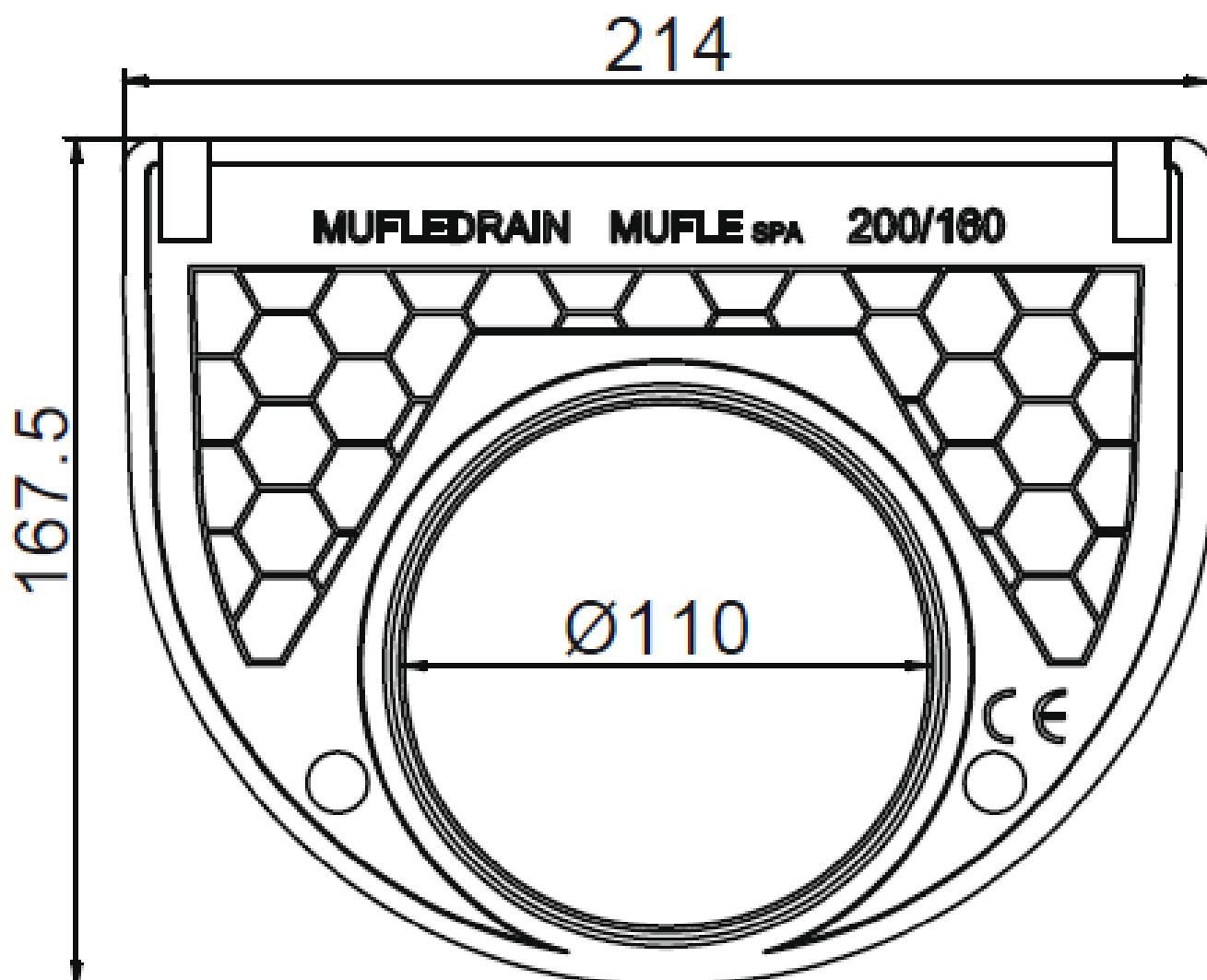

Tapa final de polietileno de alta densidad (HDPE) para canales ACO XTRALINE /G/B/S/C 200 H160 con salida DN 110. Longitud de 214 mm. Altura exterior de 167,5 mm.



Dimensiones:

Material	polietileno de alta densidad (HDPE)
Longitud (mm)	214
Altura (mm)	167,5
Salida	DN 110

