

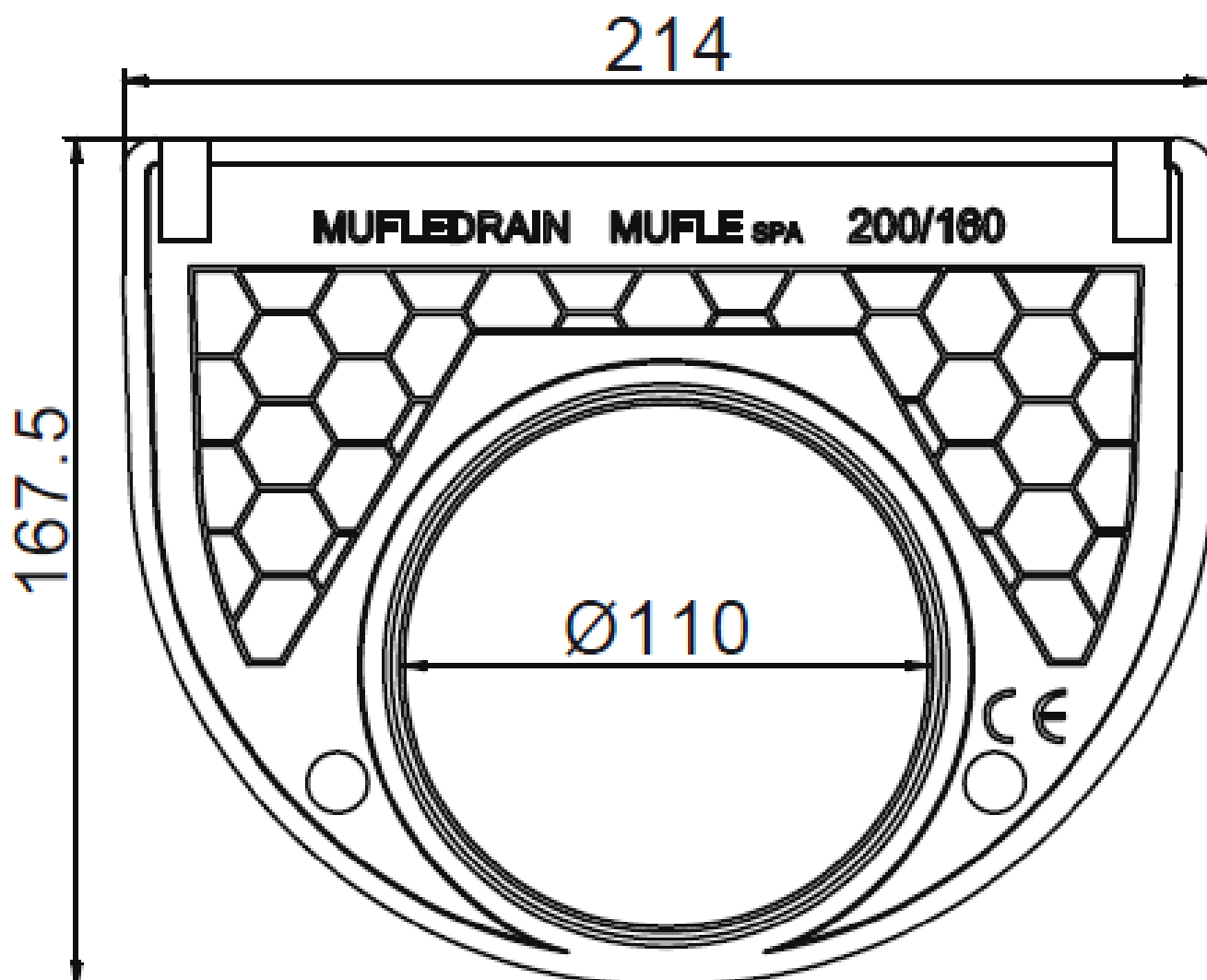

Tampão final de polietileno de alta densidade (HDPE) para canais ACO XTRALINE /G/B/S/C 200 H160 com saída DN 110. Comprimento de 214 mm. Altura exterior de 167,5 mm.

**Dimensões:**

Material	polietileno de alta densidade (HDPE)
Comprimento (mm)	214
Altura (mm)	167,5
Saída	DN 110

