

# SUM SIF AISI316 EG FIXO 200X200MM PUR S/V DN110 Ø157 C/CEST

## REF:EG446405

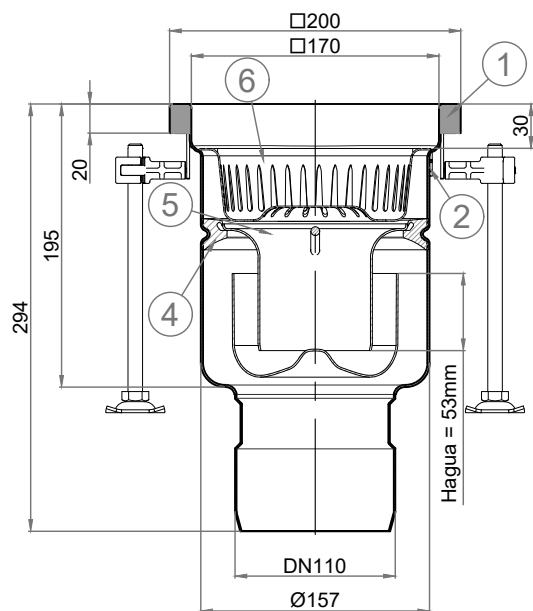

- 1 - Reforço PUR
- 2 - Conexão a terra
- 3 - Pés de nivelamento
- 4 - Junta sifão
- 5 - Sifão extraível
- 6 - Cesto

