

SUM SIF AISI316 EG FIXO Ø230MM PUR S/V DN110 Ø157 C/CEST REF:EG446737

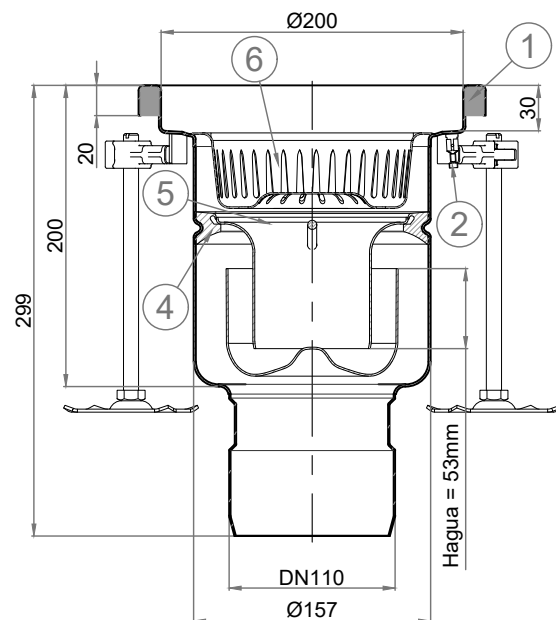

- 1 - Reforço PUR
- 2 - Conexão a terra
- 3 - Pés de nivelamento
- 4 - Junta sifão
- 5 - Sifão extraível
- 6 - Cesto

