

SUM SIF AISI316 EG FIXO Ø300MM PUR S/H DN110 Ø218 C/CEST

REF:EG446763

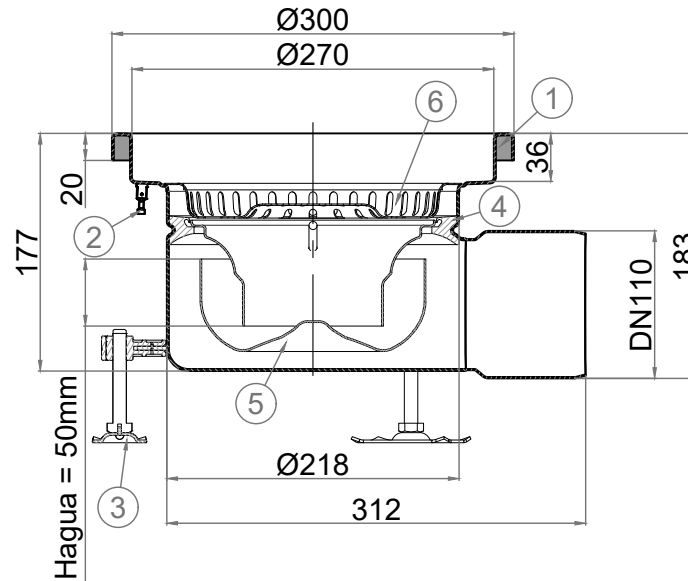

- 1 - Reforço PUR
- 2 - Conexão a terra
- 3 - Pés de nivelamento
- 4 - Junta sifão
- 5 - Sifão extraível
- 6 - Cesto

