

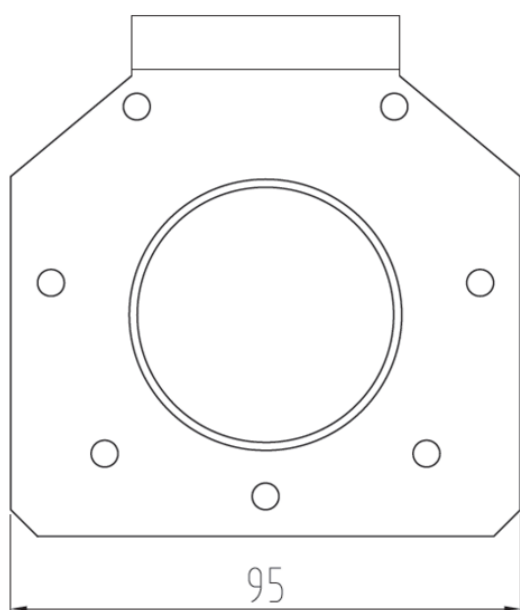

Tampão final com descarga DN50 para canal ACO ranhurado CMR20, fabricado em aço inoxidável AISI 304, para ligação a canal com altura 120 mm, com um caudal de 0,4 l/s, de acordo com a norma EN1253. Com acabamento com jateado. Peso: 0,15 kg.

Dimensões:

Material	aço inoxidável AISI 304
Peso (kg)	0,15
Altura H (mm)	120
Largura exterior (mm)	105
Acabamento	com jateado



Tubo DN50 x 1,5

