

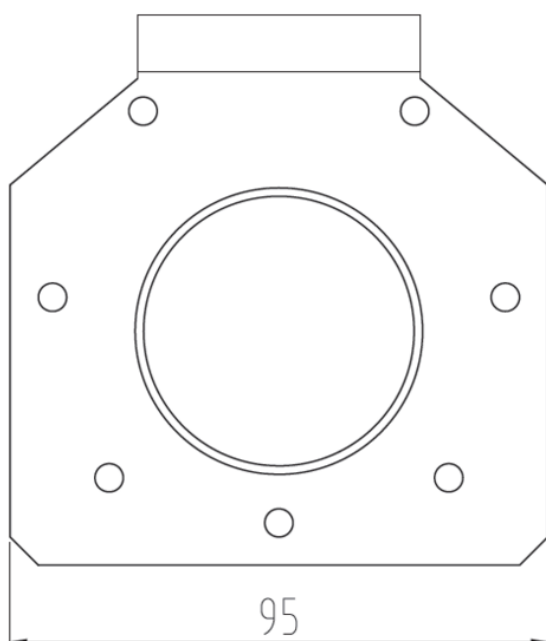

Tampão final com descarga DN50 para canal ACO ranhurado CMR20, fabricado em aço inoxidável AISI 316, para ligação a canal com altura 80 mm, com um caudal de 0,4 l/s, de acordo com a norma EN1253. Com acabamento com jateado. Peso: 0,11 kg.

#### Dimensões:

Material	aço inoxidável AISI 316
Peso (kg)	0,11
Altura H (mm)	80
Largura exterior (mm)	105
Acabamento	com jateado
R (mm)	20



Tubo DN50 x 1,5

